

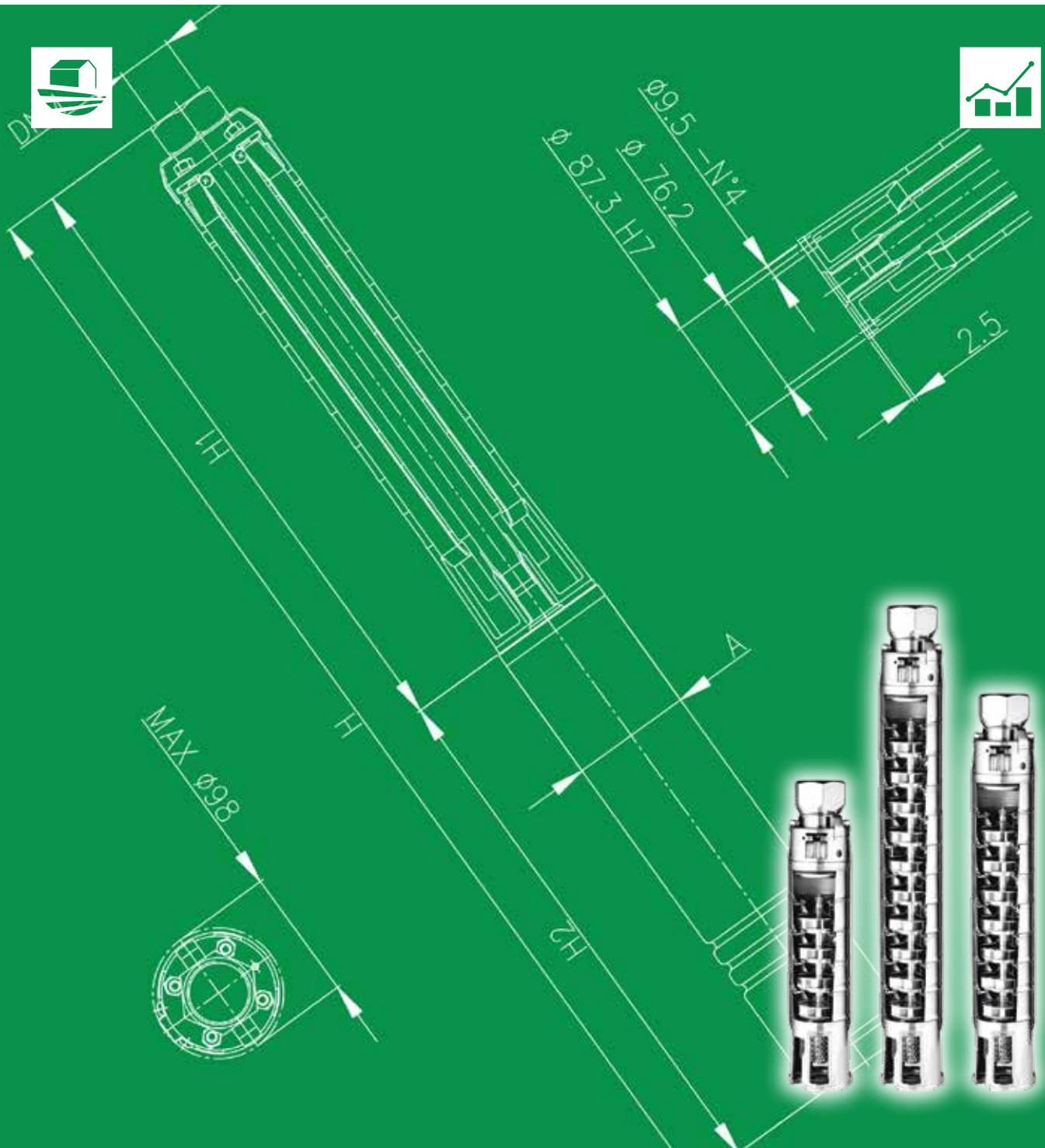

Japanese Technology since 1912

# 4BHS

Data Book 50Hz



	Page
<b>- SPECIFICATIONS</b>	<b>200</b>
SELECTION CHART	201
SELECTION CHART TABLE	202
TYPE KEY AND CURVE SPECIFICATIONS	203
PERFORMANCE CURVE 4BHS2	205
PERFORMANCE CURVE 4BHS4	206
PERFORMANCE CURVE 4BHS7	207
PERFORMANCE CURVE 4BHS15	208
<b>- CONSTRUCTIONS</b>	<b>300</b>
SECTIONAL VIEW DRAWING	300
SECTIONAL VIEW TABLE	301
QUANTITY FOR MODEL	302
INTERMEDIATE CASING WITH BEARING POSITION	303
<b>- DIMENSIONS AND WEIGHT</b>	<b>400</b>
PUMP DRAWING	400
DIMENSIONS TABLE	401
PACKING	402
<b>- TECHNICAL DATA</b>	<b>500</b>
OIL – WATER MOTOR FILLED	500
CABLE SELECTION	501-502

## SPECIFICATION

50Hz

Rev. I

PUMP		
Liquid Handled	Type of liquid	Clean water
	Temperature [°C]	Maximum 30
	Sand content	Maximum : 50 parts per million
	Chlorine ion density	Maximum : 500 parts per million
Construction	Impeller	Closed centrifugal type
	Bearing	Sleeve type - tungsten carbide
Pipe connection	Suction	N/A
	Discharge	G1 1/4 ( 4BHS2 ) - G 1 1/2 ( 4BHS4 ) - G 2 (4BHS7-4BHS15) UNI ISO 228
Material	Impeller	EN 1.4301 (AISI 304)
	Intermediate casing	EN 1.4301 (AISI 304)
	Suction casing	EN 1.4301 (AISI 304)
	Discharge casing	EN 1.4301 (AISI 304)
	Shaft	EN 1.4401 (AISI 316)
	Liner ring	EPDM / EN 1.4301 (AISI 304)
	Valve	EN 1.4301 (AISI 304)
	"O" ring	NBR
Applicable standard of test		ISO 9906 Grade 2

MOTOR					
Type		Submersible oil filled (type OY)		Submersible water filled (type WY)	
		Sumoto		Franklin	
		Single phase	Three phase	Single phase	Three phase
Power rating	[kW]	0.55÷2.2	0.55÷5.5	0.55÷2.2	0.55÷5.5
	[HP]	0.75÷3.0	0.75÷7.5	0.75÷3.0	0.75÷7.5
No. of Poles		2			
Rated speed		Refer to each characteristic performance rotation speed as rated speed			
Insulation class		F		B	
Protection degree		IP 58		IP68	
Maximum ambient temperature [m]		35		30	
Maximum immersion [m]		150		350	
Starts / hours		30		20	
Start type		Direct on line			
Frequency [Hz]		50 Hz			
Voltage [V]		230 ±10%	380-415 ±10%	230 -10%+6%	380-415 -10%+6%
Capacitor for start and run		Fitted in starter box	-	Fitted in starter box	-
Over load protection		Fitted in starter box	Provided by the user	Fitted in starter box	Provided by the user
Sealing liquid		Oil type: Marcol 82 (Esso)		Propylene Glycol 50% water solution	
Motor bracket		Brass		Brass with nickel plate	
Casing material		EN 1.4301 (AISI 304)			
Power cable	material	EPDM/Cross Seald Polyethylene			
	size [mm <sup>2</sup> ]	4x1.5			
	length [m]	L=1.75 (up to 2.2 kW) / L=2.5 (for 3 and 4 kW) / L=4 (for 5.5kW)			
Flange mount		NEMA standard			

SELECTION CHART

50Hz

Rev. I

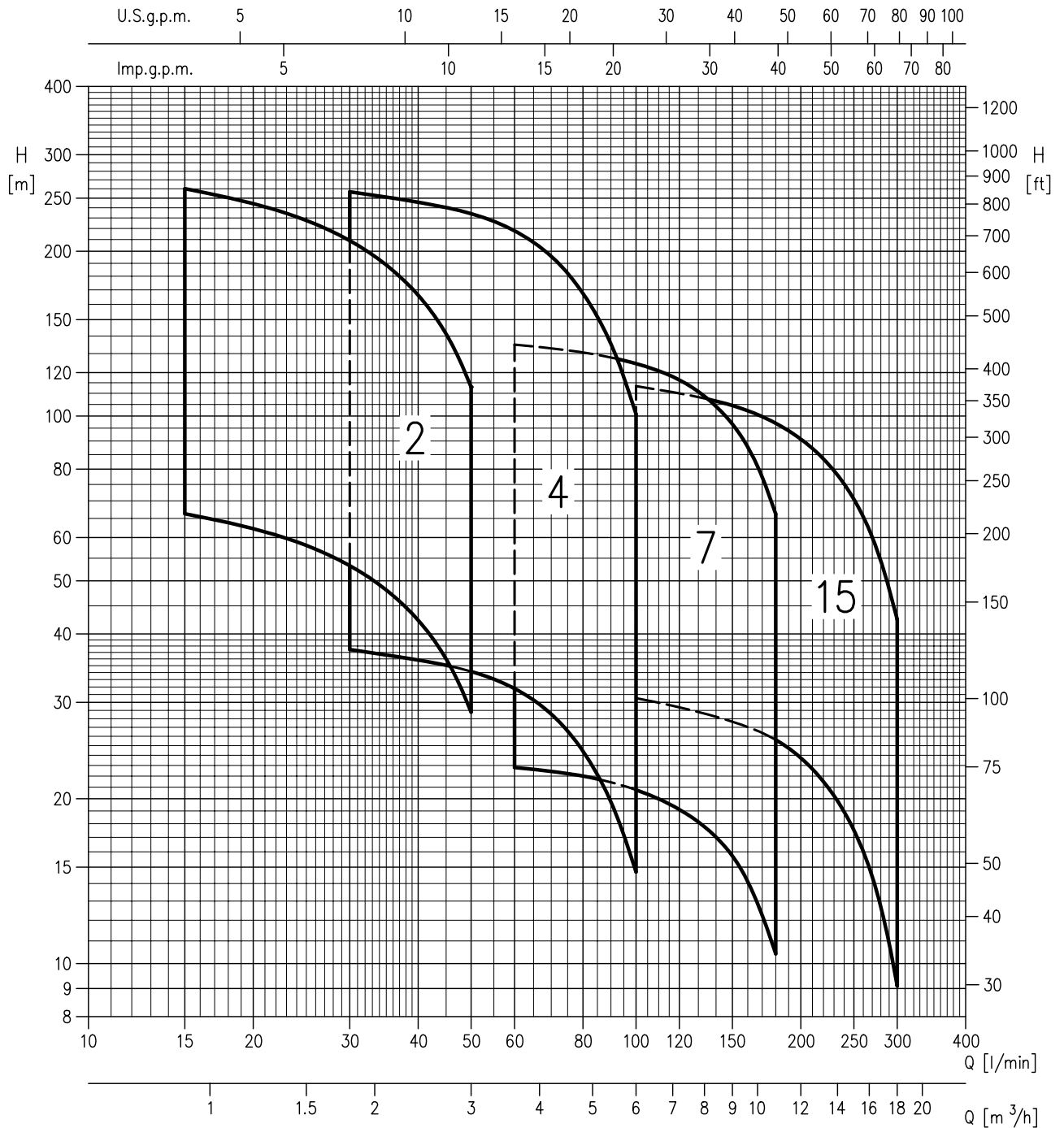

# SUBMERSIBLE MULTISTAGE PUMPS

# 4BHS

## SELECTION CHART

50Hz

Rev. I

Pump type		Power		Q=Capacity																
Single phase	Three phase	[kW]	[HP]	l/min.	15	20	30	40	50	60	80	100	120	150	180	220	260	300		
				m <sup>3</sup> /h	0,9	1,2	1,8	2,4	3,0	3,6	4,8	6	7,2	9	10,8	13,2	15,6	18		
				H=Total manometric head in meters																
4BHS2 13/5M	4BHS2 13/5	0,55	0,75	75,5	66,5	62,5	53,5	42,5	28,6	-	-	-	-	-	-	-	-	-	-	
4BHS2 18/7M	4BHS2 18/7	0,75	1,0	104,0	92,0	86,0	74,0	58,5	39,6	-	-	-	-	-	-	-	-	-	-	
4BHS2 27/11M	4BHS2 27/11	1,1	1,5	157,0	138,0	129,0	111,0	88,0	59,5	-	-	-	-	-	-	-	-	-	-	
4BHS2 36/15M	4BHS2 36/15	1,5	2,0	209,0	184,0	172,0	148,0	117,0	79,0	-	-	-	-	-	-	-	-	-	-	
4BHS2 44/22M	4BHS2 44/22	2,2	3,0	255,0	224,0	211,0	180,0	143,0	97,0	-	-	-	-	-	-	-	-	-	-	
4BHS2 51/22M	4BHS2 51/22	2,2	3,0	296,0	260,0	244,0	209,0	166,0	112,0	-	-	-	-	-	-	-	-	-	-	
4BHS4 7/5M	4BHS4 7/5	0,55	0,75	43,0	-	-	37,5	35,8	34,2	31,8	24,4	14,7	-	-	-	-	-	-	-	
4BHS4 10/7M	4BHS4 10/7	0,75	1,0	61,5	-	-	53,5	51,0	49,0	45,5	34,9	21,0	-	-	-	-	-	-	-	
4BHS4 15/11M	4BHS4 15/11	1,1	1,5	92,5	-	-	80,5	77,0	73,0	68,0	52,5	31,5	-	-	-	-	-	-	-	
4BHS4 20/15M	4BHS4 20/15	1,5	2,0	123,0	-	-	107,0	102,0	97,5	91,0	70,0	42,0	-	-	-	-	-	-	-	
4BHS4 24/22M	4BHS4 24/22	2,2	3,0	148,0	-	-	128,0	123,0	117,0	109,0	84,0	50,5	-	-	-	-	-	-	-	
4BHS4 29/22M	4BHS4 29/22	2,2	3,0	178,0	-	-	155,0	148,0	142,0	132,0	101,0	61,0	-	-	-	-	-	-	-	
/	4BHS4 36/30	3,0	4,0	221,0	-	-	193,0	184,0	176,0	163,0	126,0	75,5	-	-	-	-	-	-	-	
/	4BHS4 48/40	4,0	5,5	295,0	-	-	257,0	246,0	234,0	218,0	168,0	101,0	-	-	-	-	-	-	-	
4BHS7 4/7M	4BHS7 4/7	0,75	1,0	24,6	-	-	-	-	-	22,8	22,0	20,8	19,1	15,7	10,4	-	-	-	-	
4BHS7 7/11M	4BHS7 7/11	1,1	1,5	43,0	-	-	-	-	-	39,9	38,5	36,3	33,5	27,5	18,2	-	-	-	-	
4BHS7 10/15M	4BHS7 10/15	1,5	2,0	61,5	-	-	-	-	-	57,0	55,0	52,0	48,0	39,3	26,0	-	-	-	-	
4BHS7 12/22M	4BHS7 12/22	2,2	3,0	74,0	-	-	-	-	-	68,5	66,0	62,5	57,5	47,0	31,3	-	-	-	-	
4BHS7 14/22M	4BHS7 14/22	2,2	3,0	86,0	-	-	-	-	-	80,0	77,0	72,5	67,0	55,0	36,5	-	-	-	-	
/	4BHS7 18/30	3,0	4,0	113,0	-	-	-	-	-	106,0	102,0	97,5	91,0	75,5	52,0	-	-	-	-	
/	4BHS7 23/40	4,0	5,5	144,0	-	-	-	-	-	135,0	131,0	125,0	116,0	96,5	66,0	-	-	-	-	
*4BHS15 7/15M	*4BHS15 7/15	1,5	2,0	38,5	-	-	-	-	-	-	-	30,5	29,3	27,7	25,6	21,5	16,0	9,1		
*4BHS15 10/22M	*4BHS15 10/22	2,2	3,0	55,0	-	-	-	-	-	-	-	43,5	42,0	39,5	36,6	30,7	22,9	13,0		
/	*4BHS15 13/30	3,0	4,0	71,5	-	-	-	-	-	-	-	59,0	57,5	54,5	50,5	43,5	34,1	22,1		
/	*4BHS15 17/40	4,0	5,5	93,5	-	-	-	-	-	-	-	77,0	75,0	71,0	66,0	57,0	44,5	28,9		
/	*4BHS15 25/55	5,5	7,5	138,0	-	-	-	-	-	-	-	114,0	110,0	105,0	97,0	83,5	65,5	42,5		

\* product not available for the european market

TYPE KEY

EXAMPLE ( pump without motor ) :

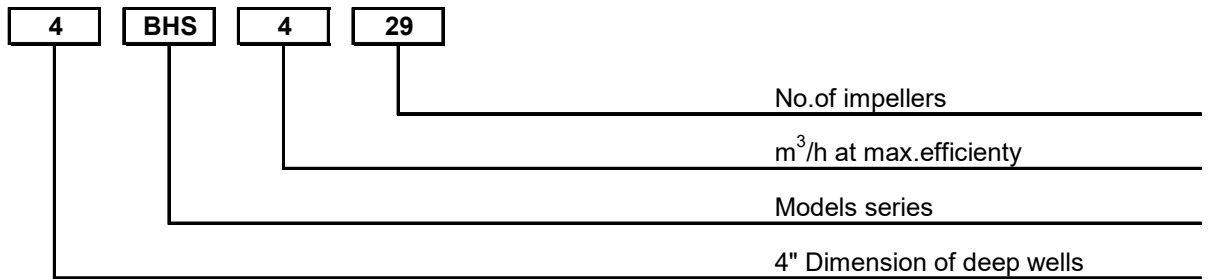

EXAMPLE ( pump with motor ) :

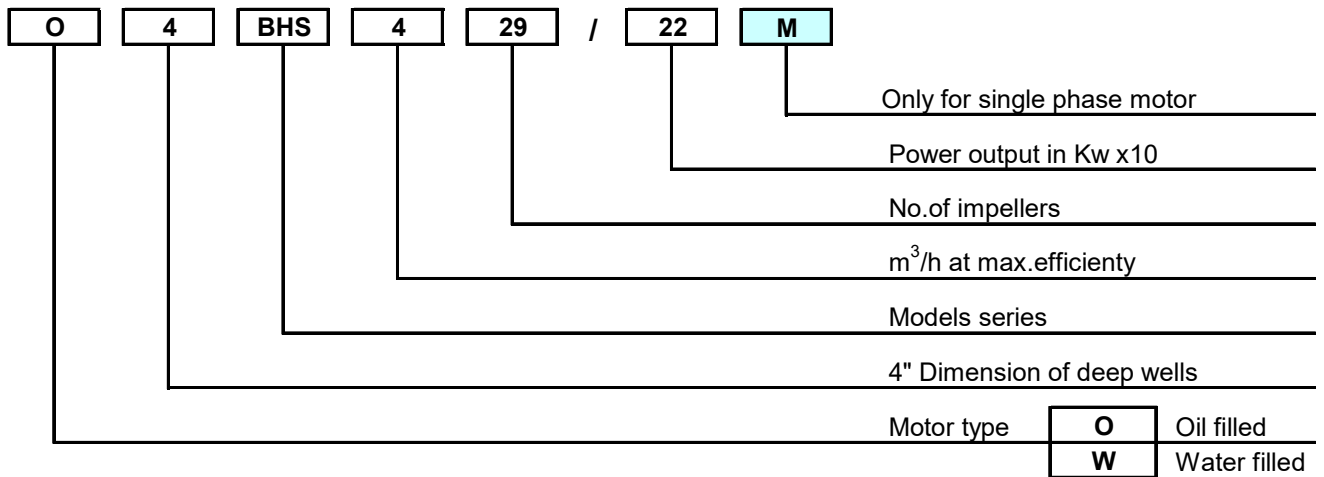

### PERFORMANCE CURVE SPECIFICATIONS

The specifications below qualify the curves shown on the following pages.

Tolerances according to ISO 9906 Annex A

The curves refer to effective speed of asynchronous motors at 50 Hz

Measurements were carried out with clean water at 20°C of temperature and with a kinematic viscosity of  $\nu = 1 \text{ mm}^2/\text{s}$  (1 cSt)

During the pump selection, consider to get a safety margin of at least 0.5 m.

The continuous curves indicate the recommended working range. The dotted curve is only a guide.

In order to avoid the risk of over-heating, the pumps should not be used at a flow rate below 10% of best efficiency point.

Symbols explanation:

- Q = volume flow rate
- H = total head
- $P_2$  = pump power input (shaft power)
- $\eta$  = pump efficiency
- NPSH = net positive suction head required by the pump
- MEI = minimum efficiency index

The minimum efficiency index (MEI) is a measure of the quality of a pump size in respect to its mean efficiency. The minimum efficiency index is based on the hydraulic efficiency and on the head at the best efficiency point.

The benchmark for most efficient water pumps is  $MEI \geq 0,70$ . Information on benchmark efficiency is Available at: [www.ebara.eu](http://www.ebara.eu)

The efficiency of a pump with trimmed impeller is usually lower than that of a pump with the full impeller diameter. The trimming of the impeller will adapt the pump to a fixed duty point, leading to reduced energy consumption. The minimum efficiency index (MEI) is based on the full impeller diameter.

The operation of these water pumps with variable duty points may be more efficient and economic when controlled, for example, by the use of a variable speed drive that matches the pump duty to the system.

MEI = 0.4 for Multistage Submersible 2900rpm

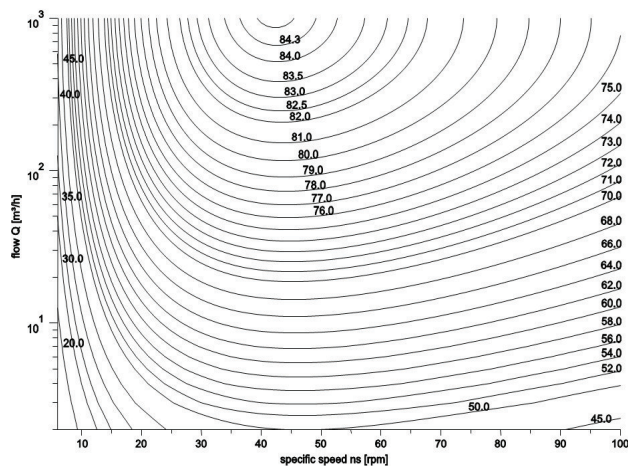

MEI = 0.7 for Multistage Submersible 2900 rpm

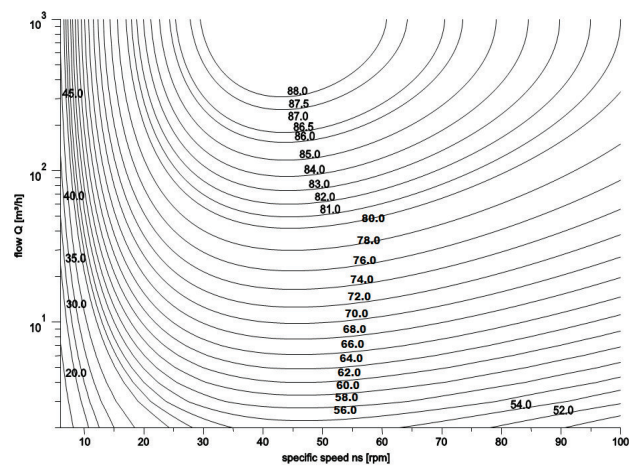

4BHS2 - MEI > 0.70 - Impeller diameter = 70.5 mm

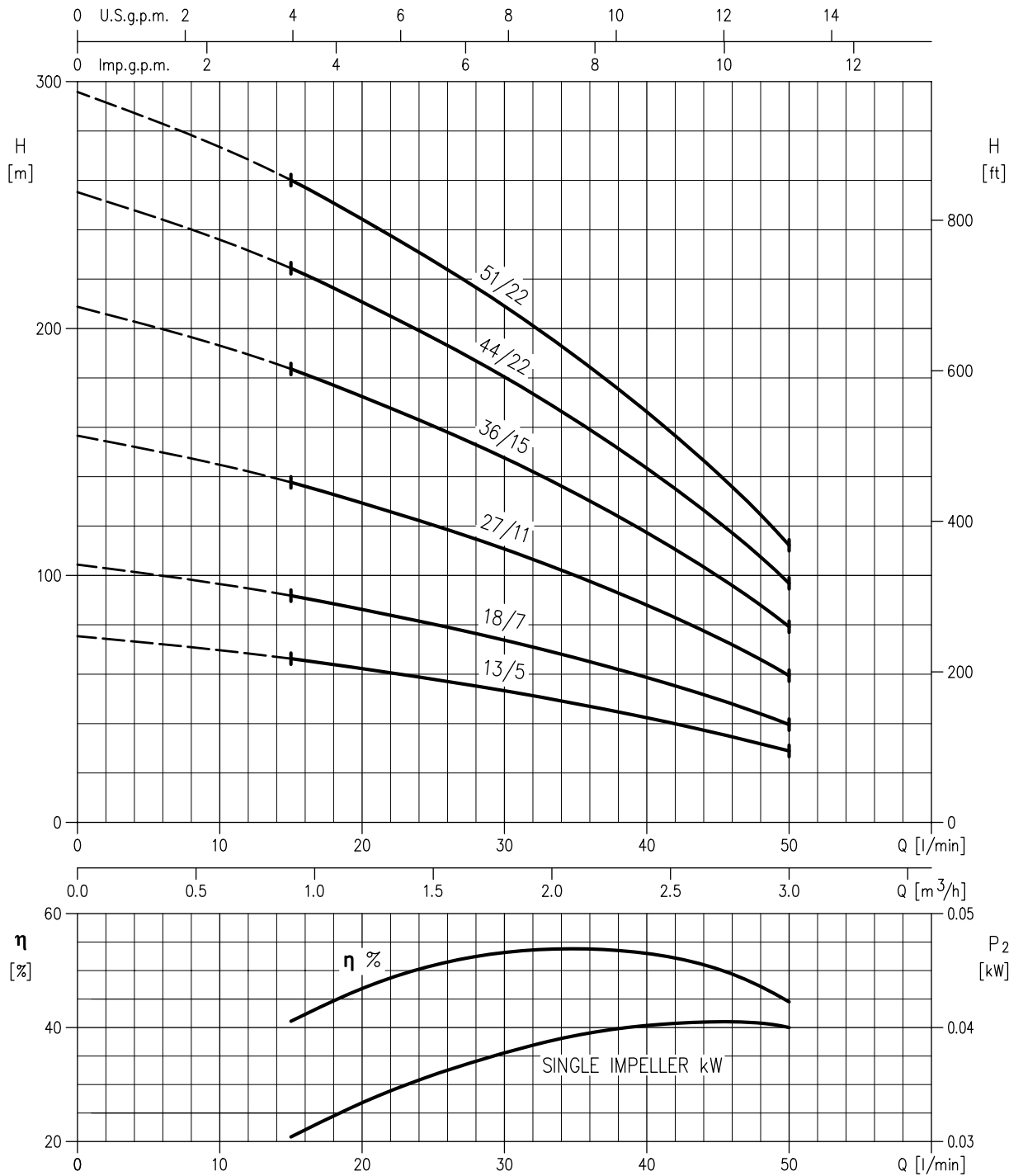

Rotation speed ≈ 2850 min<sup>-1</sup>



4BHS4 - MEI > 0.70- Impeller diameter = 72 mm

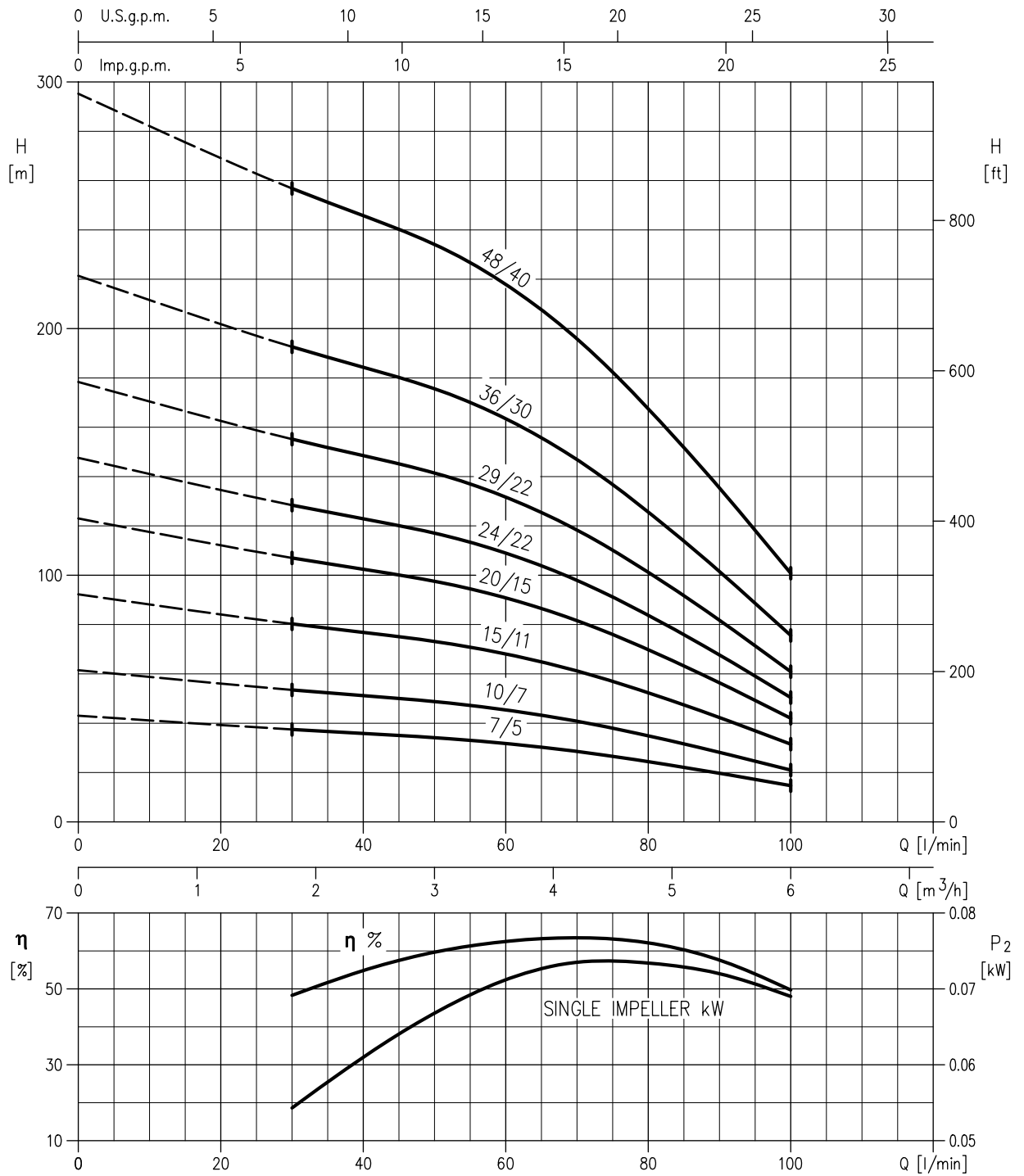

Rotation speed ≈ 2850 min<sup>-1</sup>

4BHS7 - MEI > 0.40- Impeller diameter = 74 mm

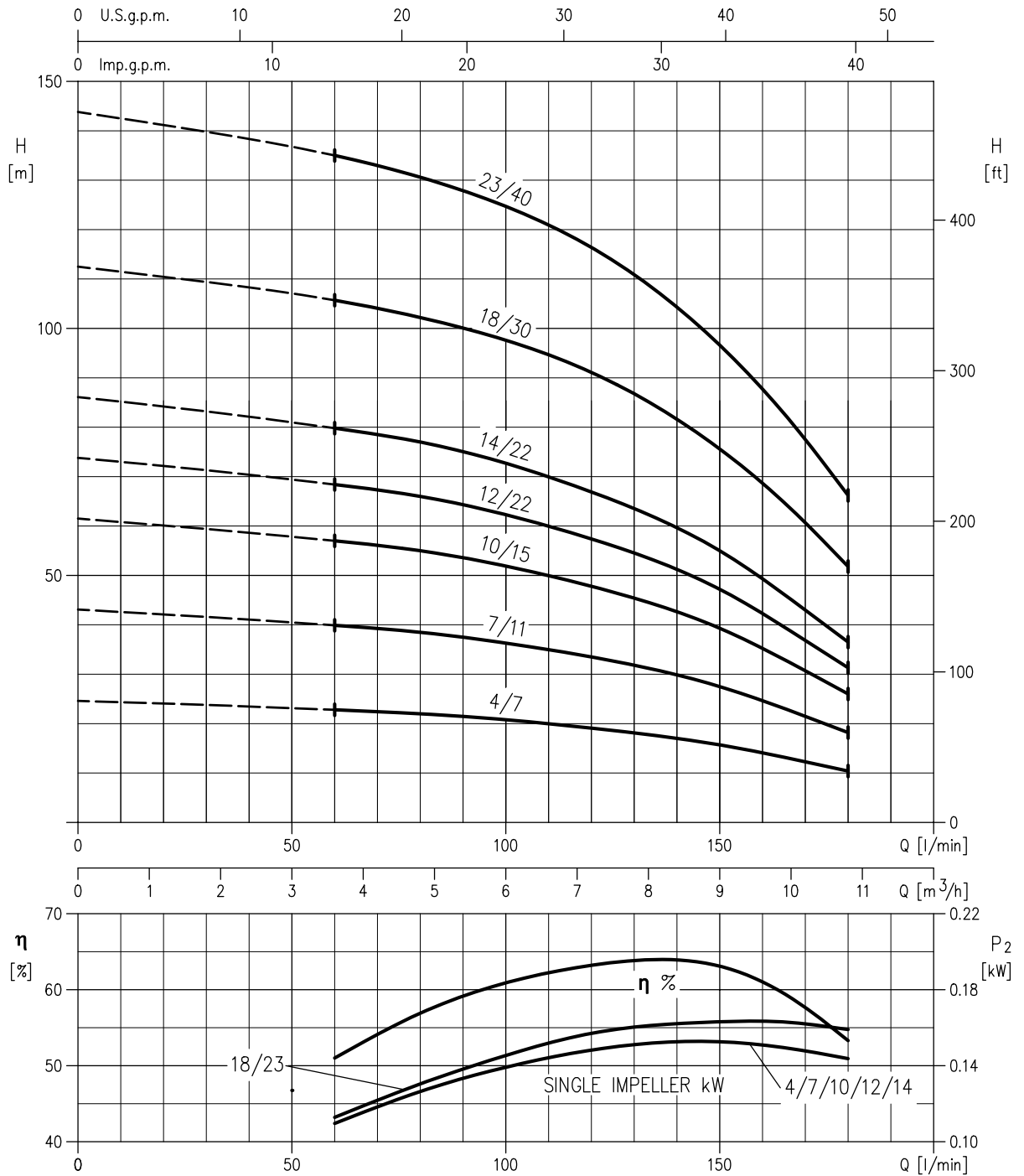

Rotation speed ≈ 2850 min<sup>-1</sup>

4BHS15 - Impeller diameter = 72 mm

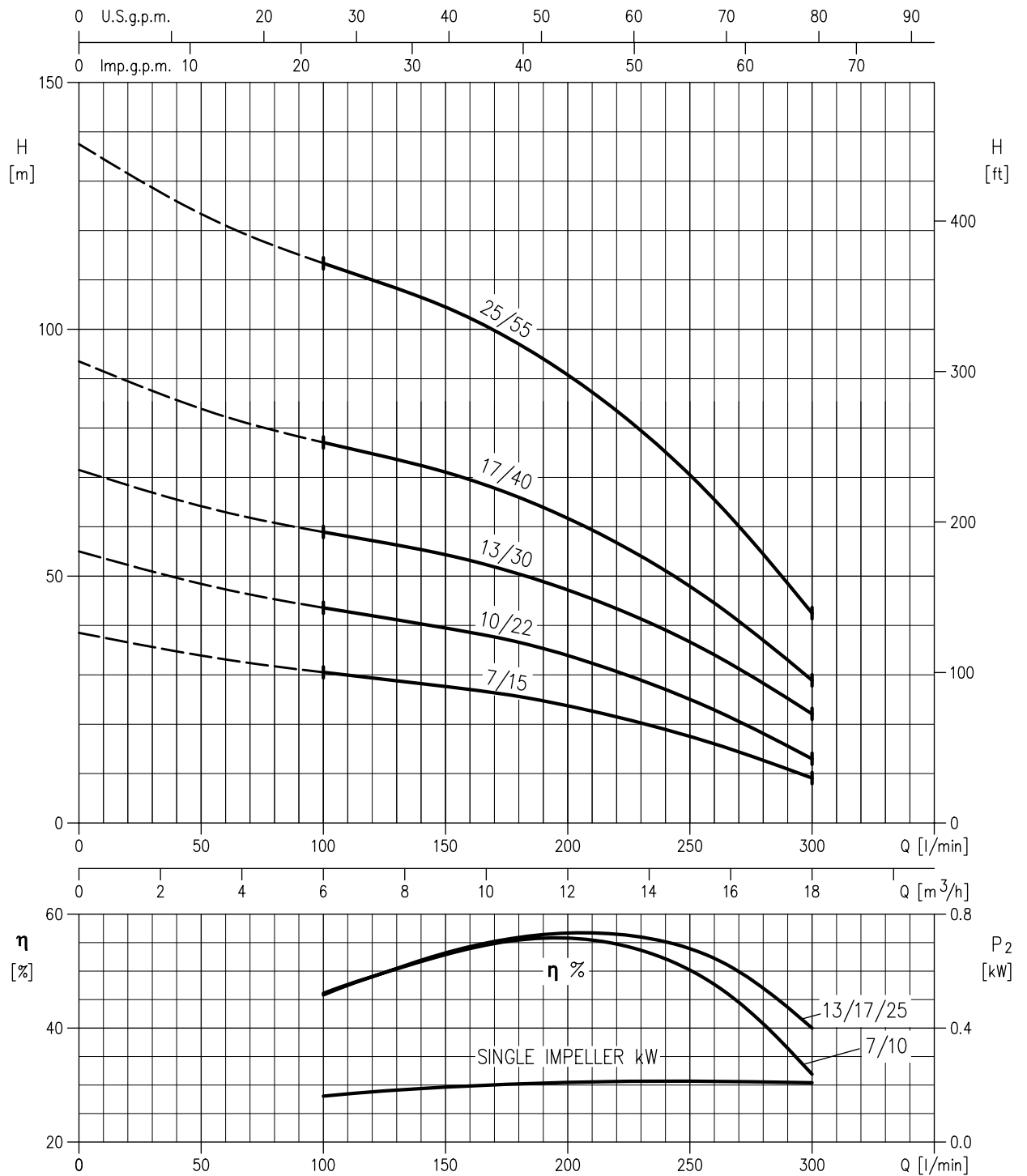

**PRODUCT NOT AVAILABLE FOR THE EUROPEAN MARKET**

Rotation speed ≈ 2850 min<sup>-1</sup>

SECTIONAL VIEW

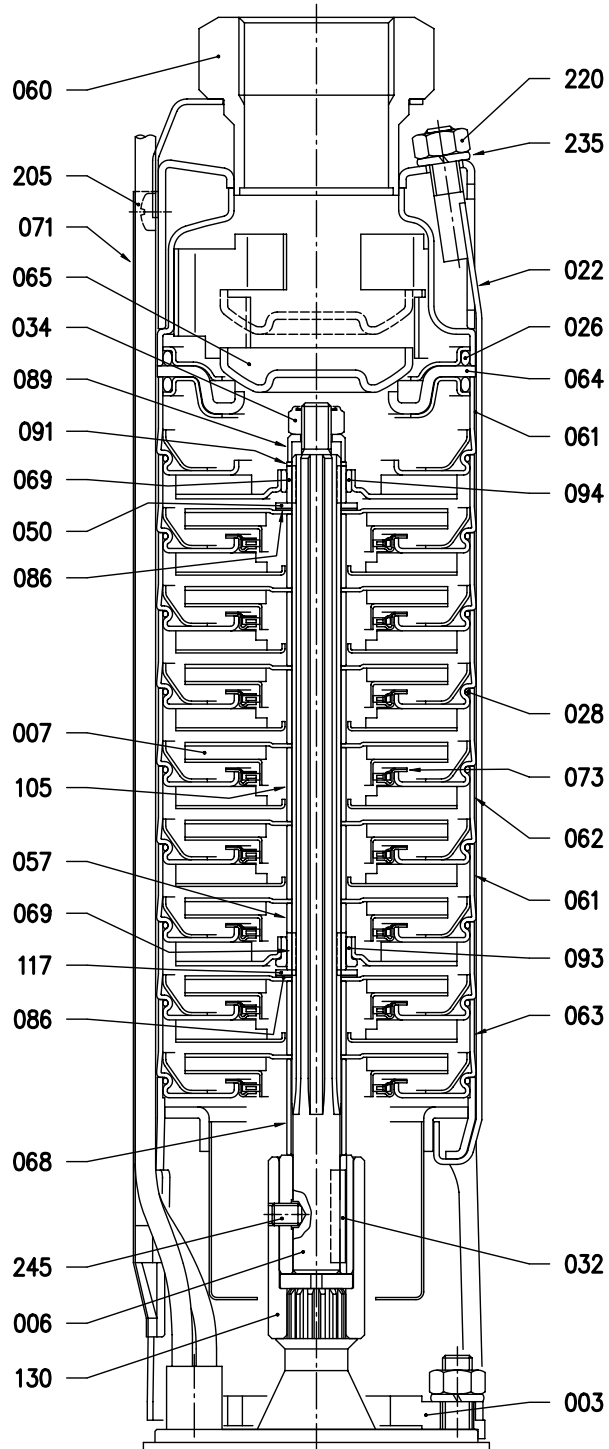

## CONSTRUCTION

50Hz

Rev. I

N°	PART.NAME	MATERIAL	DIMENSIONS	Q.TY
003	Bracket	EN 1.4301 (AISI 304)		1
006	Pump shaft	EN 1.4401 (AISI 316)		1
007	Impeller	EN 1.4301 (AISI 304)		[*]
022	Strap	EN 1.4301 (AISI 304)		4
026	"O" ring	NBR	3 x 74.5	2
028	"O" ring	NBR	1.85 x 78.4	[*]
032	Key	EN 1.4401 (AISI 316)	A 4 x 4 x 25 UNI 6604	1
034	Impeller nut self locking	EN 1.4301 (AISI 304)	M8	1
050	Washer	EN 1.4301 (AISI 304)		[*]
057	Bearing spacer	EN 1.4301 (AISI 304)		[*]
060	Discharge casing	EN 1.4301 (AISI 304)		1
061	Intermediate casing bearing	EN 1.4301 (AISI 304)		[*]
062	Intermediate casing	EN 1.4301 (AISI 304)		[*]
063	Intermediate casing suction	EN 1.4301 (AISI 304)		1
064	Valve seat	EN 1.4301 (AISI 304) + NBR		1
065	Valve	EN 1.4301 (AISI 304)		1
068	Spacer	EN 1.4301 (AISI 304)		1
069	Shaft sleeve	Tungsten carbide		[*]
071	Cable cover	EN 1.4301 (AISI 304)		1
073	Liner ring	EN 1.4301 (AISI 304) + EPDM		[*]
086	Spacer	EN 1.4301 (AISI 304)		[*]
089	Washer	EN 1.4301 (AISI 304)		1
091	Spacer	EN 1.4301 (AISI 304)		[*]
093	Axial bearing	Tungsten carbide		1
094	Radial bearing	Tungsten carbide		[*]
105	Spacer	EN 1.4301 (AISI 304)		[*]
117	Friction ring	Tungsten carbide		1
130	Coupling	EN 1.4301 (AISI 304)		1
205	Screw	EN 1.4301 (AISI 304)	M5 x 6 UNI 7687	2
220	Nut	EN 1.4301 (AISI 304)	M8 UNI 5588	4
235	Washer	EN 1.4301 (AISI 304)	8,4 UNI 1751	4
245	Set screw	EN 1.4301 (AISI 304)	M6 x 8 UNI 5923	1

[\*] See table pag. 302

**QUANTITY FOR MODEL**

Pumptype	Quantity for model											
	N°007	N°028	N°050	N°057	N°061	N°062	N°069	N°073	N°086	N°091	N°094	N°105
4BHS2 13	13	14	/	0	1	12	1	13	1	1	0	12
4BHS2 18	18	19	1	1	2	16	2	18	2	1	1	16
4BHS2 27	27	28	1	1	2	25	2	27	2	1	1	25
4BHS2 36	36	37	2	2	3	33	3	36	3	1	2	33
4BHS2 44	44	45	3	3	4	40	4	44	4	1	3	40
4BHS2 51	51	52	3	3	4	47	4	51	4	1	3	47
4BHS4 7	7	8	/	0	1	6	1	7	1	1	0	6
4BHS4 10	10	11	/	0	1	9	1	10	1	1	0	9
4BHS4 15	15	16	/	0	1	14	1	15	1	1	0	14
4BHS4 20	20	21	1	1	2	18	2	20	2	1	1	18
4BHS4 24	24	25	1	1	2	22	2	24	2	1	1	22
4BHS4 29	29	30	2	2	3	26	3	29	3	1	2	26
4BHS4 36	36	37	2	2	3	33	3	36	3	1	2	33
4BHS4 48	48	49	3	3	4	44	4	48	4	1	3	44
4BHS7 4	4	5	/	0	1	4	1	4	/	/	0	3
4BHS7 7	7	8	/	0	1	6	1	7	/	/	0	6
4BHS7 10	10	11	/	0	1	9	1	10	/	/	0	9
4BHS7 12	12	13	1	1	2	10	2	12	/	/	1	10
4BHS7 14	14	15	1	1	2	12	2	14	/	/	1	12
4BHS7 18	18	19	1	1	2	16	2	18	/	/	1	16
4BHS7 23	23	24	2	2	3	20	3	23	/	/	2	20
4BHS15 7	7	8	/	0	1	6	1	7	/	/	0	6
4BHS15 10	10	11	1	1	2	8	2	10	/	/	1	8
4BHS15 13	13	14	1	1	2	11	2	13	/	/	1	11
4BHS15 17	17	18	2	2	3	14	3	17	/	/	2	14
4BHS15 25	25	26	3	3	4	21	4	25	/	/	3	21

## INTERMEDIATE CASING WITH BEARING POSITION

Pump type	N° impeller	Intermediate casing with bearing					
		Quantity for model		Position *			
		axial	radial				
4BHS2 13	13	1	/				14th
4BHS2 18	18	1	1	5th			19th
4BHS2 27	27	1	1	5th			28th
4BHS2 36	36	1	2	5th	20th		37th
4BHS2 44	44	1	3	5th	20th	35th	45th
4BHS2 51	51	1	3	5th	20th	35th	52th
4BHS4 7	7	1	/				8th
4BHS4 10	10	1	/				11th
4BHS4 15	15	1	/				16th
4BHS4 20	20	1	1	5th			21th
4BHS4 24	24	1	1	5th			25th
4BHS4 29	29	1	2	5th	20th		30th
4BHS4 36	36	1	2	5th	20th		37th
4BHS4 48	48	1	3	5th	20th	35th	49th
4BHS7 4	4	1	/				5th
4BHS7 7	7	1	/				8th
4BHS7 10	10	1	/				11th
4BHS7 12	12	1	1	4th			13th
4BHS7 14	14	1	1	4th			15th
4BHS7 18	18	1	1	4th			19th
4BHS7 23	23	1	2	4th	16th		24th
4BHS15 7	7	1	/				8th
4BHS15 10	10	1	1	3th			11th
4BHS15 13	13	1	1	3th			14th
4BHS15 17	17	1	2	3th	12th		18th
4BHS15 25	25	1	3	3th	12th	21th	26th

\* the first intermediate suction casing is used as reference for the position of the bearing

 axial bearing

PUMP

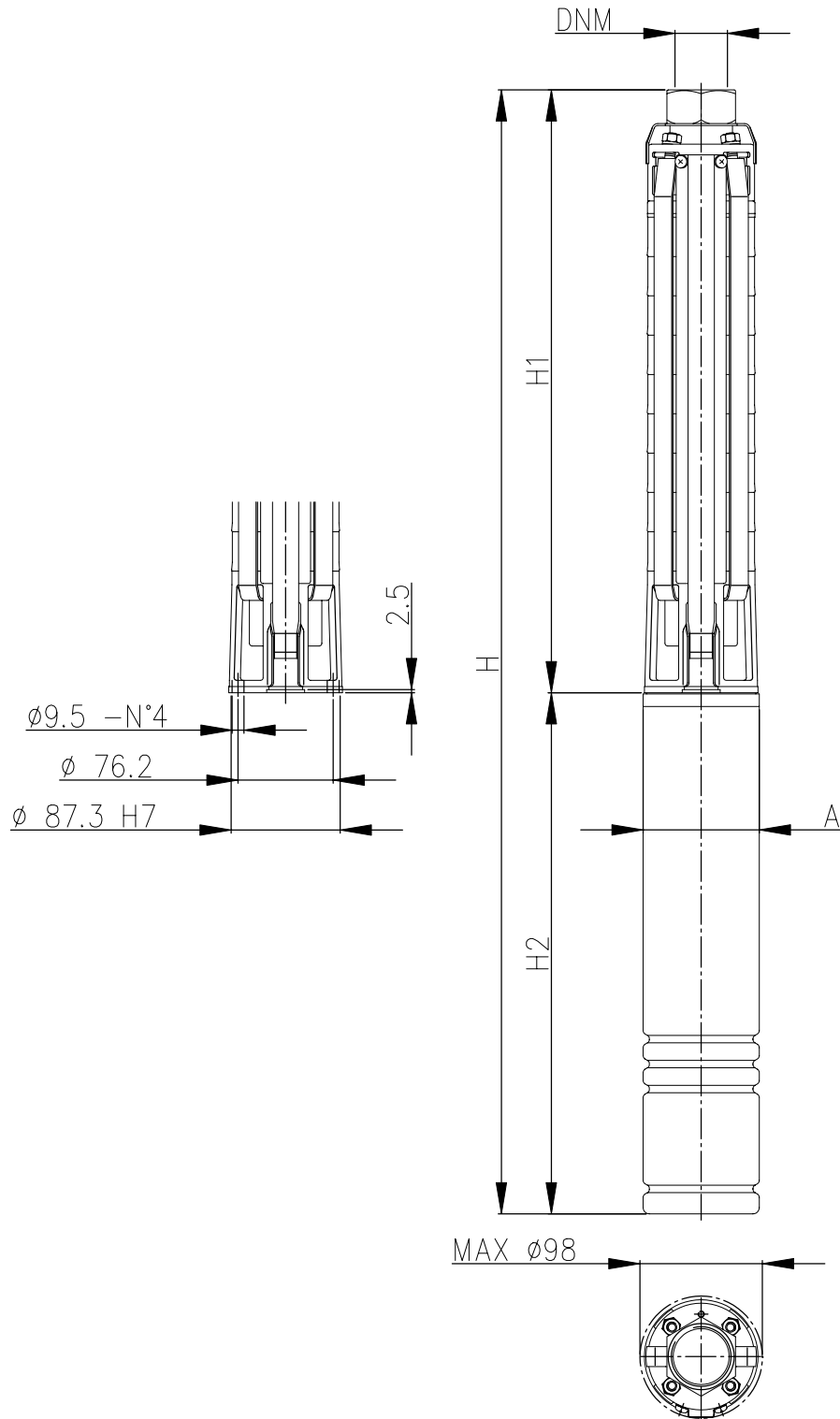



## DIMENSIONS

50Hz

Rev. I

Pump type	Power		Pump without motor		Pump with oil filled motor						Pump with water filled motor					
	[kW]	[HP]	DNM	H1 [mm]	single phase			three phase			single phase			three phase		
					A [mm]	H2 [mm]	H [mm]	A [mm]	H2 [mm]	H [mm]	A [mm]	H2 [mm]	H [mm]	A [mm]	H2 [mm]	H [mm]
4BHS2 13/5	0,55	0.75	G 1 1/4	489	97	325	814	97	325	814	91	248	737	91	228	717
4BHS2 18/7	0,75	1.0	G 1 1/4	594	97	350	944	97	325	919	91	283	877	91	248	842
4BHS2 27/11	1,1	1.5	G 1 1/4	783	97	385	1168	97	350	1133	91	339	1122	91	283	1066
4BHS2 36/15	1,5	2.0	G 1 1/4	972	97	420	1392	97	385	1357	91	350	1322	91	307	1279
4BHS2 44/22	2,2	3.0	G 1 1/4	1140	97	470	1610	97	420	1560	91	437	1577	91	339	1479
4BHS2 51/22	2,2	3.0	G 1 1/4	1287	97	470	1757	97	420	1707	91	437	1724	91	339	1626
4BHS4 7/5	0,55	0.75	G 1 1/2	368	97	325	693	97	325	693	91	248	616	91	228	596
4BHS4 10/7	0,75	1.0	G 1 1/2	431	97	350	781	97	325	756	91	283	714	91	248	679
4BHS4 15/11	1,1	1.5	G 1 1/2	536	97	385	921	97	350	886	91	339	875	91	283	819
4BHS4 20/15	1,5	2.0	G 1 1/2	641	97	420	1061	97	385	1026	91	350	991	91	307	948
4BHS4 24/22	2,2	3.0	G 1 1/2	725	97	470	1195	97	420	1145	91	437	1162	91	339	1064
4BHS4 29/22	2,2	3.0	G 1 1/2	830	97	470	1300	97	420	1250	91	437	1267	91	339	1169
4BHS4 36/30	3,0	4.0	G 1 1/2	977	97	/	/	97	544	1521	91	/	/	91	394	1371
4BHS4 48/40	4,0	5.5	G 1 1/2	1229	97	/	/	97	574	1803	91	/	/	91	543	1772
4BHS7 4/7	0,75	1.0	G 2	373	97	350	723	97	325	698	91	283	656	91	248	621
4BHS7 7/11	1,1	1.5	G 2	468	97	385	853	97	350	818	91	339	807	91	283	751
4BHS7 10/15	1,5	2.0	G 2	562	97	420	982	97	385	947	91	350	912	91	307	869
4BHS7 12/22	2,2	3.0	G 2	625	97	470	1095	97	420	1045	91	437	1062	91	339	964
4BHS7 14/22	2,2	3.0	G 2	688	97	470	1158	97	420	1108	91	437	1125	91	339	1027
4BHS7 18/30	3,0	4.0	G 2	814	97	/	/	97	544	1358	91	/	/	91	394	1208
4BHS7 23/40	4,0	5.5	G 2	972	97	/	/	97	574	1546	91	/	/	91	543	1515
4BHS15 7/15	1,5	2.0	G 2	552	97	420	972	97	385	937	91	350	902	91	307	859
4BHS15 10/22	2,2	3.0	G 2	678	97	470	1148	97	420	1098	91	437	1115	91	339	1017
4BHS15 13/30	3,0	4.0	G 2	804	97	/	/	97	544	1348	91	/	/	91	394	1198
4BHS15 17/40	4,0	5.5	G 2	972	97	/	/	97	574	1546	91	/	/	91	543	1515
4BHS15 25/55	5,5	7.5	G 2	1308	97	/	/	97	644	1952	91	/	/	91	653	1961

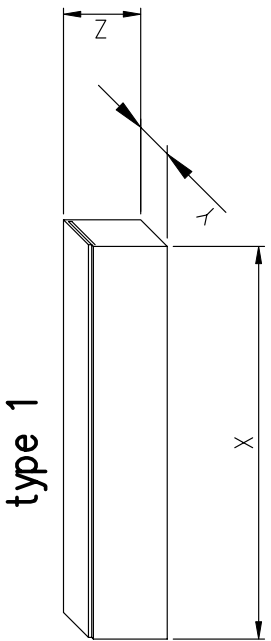
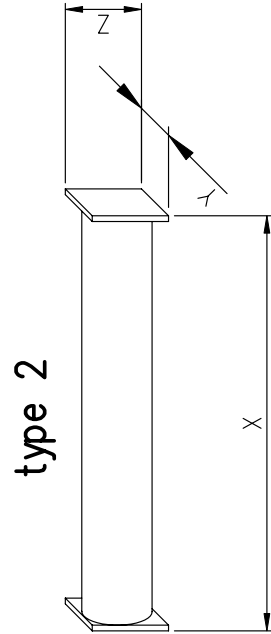

Pump type	Pump without motor						Pump with oil filled motor						Pump with water filled motor												
	Single phase		Three phase		Single phase		Three phase		Single phase		Three phase		Single phase		Three phase										
	X [mm]	Y [mm]	Z [mm]	weight [kgf]	type	X [mm]	Y [mm]	Z [mm]	weight [kgf]	type	X [mm]	Y [mm]	Z [mm]	weight [kgf]	type	X [mm]	Y [mm]	Z [mm]	weight [kgf]	type					
4BHS2 13/5	495	100	100	6.6	1	1035	100	100	14.2	1	1035	100	100	13.6	1	800	100	100	15.1	1	800	100	100	14.4	1
4BHS2 18/7	640	100	100	8.3	1	1035	100	100	17	1	1035	100	100	15.9	1	800	100	100	18.3	1	1035	100	100	16.9	1
4BHS2 27/11	800	100	100	11	1	1300	100	100	21.3	1	1300	100	100	19.7	1	1300	100	100	22.8	1	1300	100	100	20.5	1
4BHS2 36/15	1035	100	100	13.8	1	1530	100	100	25.8	1	1530	100	100	24.2	1	1530	100	100	27.5	1	1530	100	100	24.9	1
4BHS2 44/22	1300	100	100	16.5	1	1810	110	110	32	2	1810	110	110	30.7	2	1810	110	110	32.9	2	1810	110	110	30.3	1
4BHS2 51/22	1300	100	100	18.7	1	1950	110	110	34.2	2	1950	110	110	32.9	2	1950	110	110	35.1	2	1810	110	110	32.5	2
4BHS4 7/5	495	100	100	4.4	1	800	100	100	12	1	800	100	100	11.4	1	800	100	100	12.9	1	800	100	100	12.2	1
4BHS4 10/7	495	100	100	5.5	1	800	100	100	14.2	1	800	100	100	13.1	1	800	100	100	15.5	1	800	100	100	14.1	1
4BHS4 15/11	640	100	100	7.2	1	1035	100	100	17.5	1	1035	100	100	15.9	1	1035	100	100	19	1	1035	100	100	16.7	1
4BHS4 20/15	640	100	100	8.3	1	1300	100	100	20.3	1	1300	100	100	18.7	1	1300	100	100	22	1	1035	100	100	19.4	1
4BHS4 24/22	800	100	100	9.9	1	1300	100	100	25.4	1	1300	100	100	24.1	1	1300	100	100	26.3	1	1300	100	100	23.7	1
4BHS4 29/22	1035	100	100	11.5	1	1530	100	100	27	1	1530	100	100	25.7	1	1530	100	100	27.9	1	1300	100	100	25.3	1
4BHS4 36/30	1035	100	100	14.3	1	/	/	/	/	/	1810	110	110	33.3	2	/	/	/	/	/	1530	100	100	31.6	1
4BHS4 48/40	1300	100	100	17.6	1	/	/	/	/	/	1950	110	110	37.6	2	/	/	/	/	/	1950	110	110	38.8	2
4BHS7 4/7	495	100	100	4.2	1	800	100	100	12.9	1	800	100	100	11.8	1	800	100	100	14.2	1	800	100	100	12.8	1
4BHS7 7/11	495	100	100	5	1	1035	100	100	15.3	1	1035	100	100	13.7	1	1035	100	100	16.8	1	800	100	100	14.5	1
4BHS7 10/15	640	100	100	6.6	1	1035	100	100	18.6	1	1035	100	100	17	1	1035	100	100	20.3	1	1035	100	100	17.7	1
4BHS7 12/22	640	100	100	7.7	1	1300	100	100	23.2	1	1300	100	100	21.9	1	1300	100	100	24.1	1	1035	100	100	21.5	1
4BHS7 14/22	800	100	100	8.3	1	1300	100	100	23.8	1	1300	100	100	22.5	1	1300	100	100	24.7	1	1300	100	100	22.1	1
4BHS7 18/30	1035	100	100	9.9	1	/	/	/	/	/	1530	100	100	28.9	1	/	/	/	/	/	1530	100	100	27.2	1
4BHS7 23/40	1035	100	100	11.5	1	/	/	/	/	/	1810	/	/	31.5	2	/	/	/	/	/	1810	110	110	32.7	2
4BHS15 7/15	640	100	100	5.8	1	1035	100	100	17.8	1	1035	100	100	16.2	1	1035	100	100	19.5	1	1035	100	100	16.9	1
4BHS15 10/22	800	100	100	7.3	1	1300	100	100	22.8	1	1300	100	100	21.5	1	1300	100	100	23.7	1	1300	100	100	21.1	1
4BHS15 13/30	1035	100	100	8.7	1	/	/	/	/	/	1530	100	100	27.7	1	/	/	/	/	/	1530	100	100	26	1
4BHS15 17/40	1035	100	100	10.7	1	/	/	/	/	/	1810	110	110	30.7	2	/	/	/	/	/	1810	110	110	31.9	2
4BHS15 25/55	1530	100	100	14.4	1	/	/	/	/	/	2110	110	110	36.8	2	/	/	/	/	/	2110	110	110	40.6	2

### MOTOR DATA

#### OIL FILLED MOTOR

Power		Hight thrust [N]	Single phase 230 V				Three phase 380 V				Three phase 415 V			
[kW]	[HP]		Input [kW]	IN [A]	IA [A]	Power factor	Input [kW]	IN [A]	IA [A]	Power factor	Input [kW]	IN [A]	IA [A]	Power factor
0,55	0,75	1500	0,97	4,5	13,6	0,94	0,94	1,9	7,0	0,75	1,08	2,0	7,0	0,75
0,75	1	1500	1,32	6,0	18,5	0,96	1,17	2,4	10,0	0,74	1,38	2,6	10,0	0,74
1,1	1,5	1500	1,83	8,2	26,0	0,97	1,56	3,2	14,0	0,74	1,81	3,4	14,0	0,74
1,5	2	1500	2,48	11,0	34,0	0,98	2,09	4,4	17,0	0,72	2,38	4,6	17,0	0,72
2,2	3	4400	3,27	14,8	48,0	0,96	-	-	-	-	-	-	-	-
2,2	3	1500	-	-	-	-	3,00	6	24,0	0,76	3,39	6,2	24,0	0,76
2,2	3	5000	-	-	-	-	3,02	5,6	23,0	0,82	3,42	5,8	23,0	0,82
3	4	5000	-	-	-	-	4,05	7,7	30,0	0,80	4,49	7,8	30,0	0,80
4	5,5	5000	-	-	-	-	5,24	9,7	45,0	0,82	5,78	9,8	45,0	0,82
5,5	7,5	5000	-	-	-	-	7,37	13,5	55,0	0,83	8,23	13,8	55,0	0,83

#### WATER FILLED MOTOR

Power		Hight thrust [N]	Single phase 230 V				Three phase 380 V				Three phase 415 V			
[kW]	[HP]		Input [kW]	IN [A]	IA [A]	Power factor	Input [kW]	IN [A]	IA [A]	Power factor	Input [kW]	IN [A]	IA [A]	Power factor
0,55	0,75	3000	0,93	4,3	17,7	0,94	0,83	1,6	7	0,79	0,86	1,7	7,7	0,7
0,75	1	3000	1,28	5,7	22,7	0,98	1,07	2,0	10,1	0,81	1,10	2,1	10,9	0,73
1,1	1,5	3000	1,78	8,4	33,9	0,92	1,51	2,8	15,3	0,82	1,54	2,9	16,7	0,74
1,5	2	3000	2,34	10,7	41,7	0,95	2,13	3,9	19,7	0,83	2,10	4	21,5	0,73
2,2	3	4000	3,28	14,7	61,8	0,97	2,91	5,4	28,3	0,82	3,00	5,8	30,9	0,72
3	4	4000	-	-	-	-	3,99	7,4	39,9	0,82	4,09	7,9	43,6	0,72
4	5,5	6500	-	-	-	-	5,24	9,7	54,1	0,82	5,38	10,4	59,1	0,72
5,5	7,5	6500	-	-	-	-	7,05	12,6	73,3	0,85	7,08	12,8	80,1	0,77

**OIL FILLED MOTORS CABLE SELECTION**

EXAMPLE : MOTOR 0.75 kW 230 V CABLE LENGTH 75 m - 4x2,5 mm<sup>2</sup>

**Single phase 230 V**

POWER		CABLE TYPE AND MAXIMUM LENGTH (*)							
[kW]	[HP]	4x1	4x1,5	4x2	4x2,5	4x4	4x6	4x10	4x16
0.55	0.75	38	57	76	95	152	-	-	-
0.75	1	30	45	60	75	120	174	-	-
1.1	1.5	22	33	43	53	85	127	210	-
1.5	2	-	23	31	38	63	92	154	246
2.2	3	-	-	22	28	45	67	112	180

**Three phase 380-415 V**

POWER		CABLE TYPE AND MAXIMUM LENGTH (*)							
[kW]	[HP]	4x1	4x1,5	4x2	4x2,5	4x4	4x6	4x10	4x16
0.55	0.75	164	246	328	-	-	-	-	-
0.75	1	133	200	266	333	-	-	-	-
1.1	1.5	97	146	195	244	390	-	-	-
1.5	2	72	109	145	180	290	435	-	-
2.2	3	51	78	103	130	207	310	516	-
3	4	41	62	83	104	167	250	416	-
4	5.5	31	46	62	77	124	186	310	496
5.5	7.5	-	33	45	56	90	135	225	360

(\*) Maximum cable length with a voltage drop of 3% at 30°C ambient temperature.

If the operating voltage  $U_i$  in the installation is different from the nominal voltage  $U_n$ , it is possible to calculate the permissible maximum length  $L_{max}$ , with the given table length  $L_{tab}$ , with the following formula:

$$L_{max} = L_{tab} (U_i / U_n)^2$$

### WATER FILLED MOTORS CABLE SELECTION

EXAMPLE : MOTOR 0.75 kW 230 V CABLE LENGTH 73 m - 4x2,5 mm<sup>2</sup>

#### Single phase 230 V

POWER		CABLE TYPE AND MAXIMUM LENGTH (*)							
[kW]	[HP]	4x1	4x1,5	4x2	4x2,5	4x4	4x6	4x10	4x16
0.55	0.75	39	58	77	97	155	-	-	-
0.75	1	29	44	58	73	117	175	-	-
1.1	1.5	20	30	40	50	79	119	198	-
1.5	2	-	23	31	39	62	93	156	249
2.2	3	-	-	23	28	45	68	113	181

#### Three phase 380-415 V

POWER		CABLE TYPE AND MAXIMUM LENGTH (*)							
[kW]	[HP]	4x1	4x1,5	4x2	4x2,5	4x4	4x6	4x10	4x16
0.55	0.75	223	335	446	-	-	-	-	-
0.75	1	167	251	335	418	-	-	-	-
1.1	1.5	120	179	239	299	478	-	-	-
1.5	2	86	129	172	215	343	515	-	-
2.2	3	61	91	122	152	243	365	609	-
3	4	45	67	89	112	179	268	446	-
4	5.5	34	51	68	85	135	203	338	541
5.5	7.5	-	40	53	66	106	159	266	425

(\*) Maximum cable length with a voltage drop of 3% at 30°C ambient temperature.

If the operating voltage  $U_i$  in the installation is different from the nominal voltage  $U_n$ , it is possible to calculate the permissible maximum length  $L_{max}$ , with the given table length  $L_{tab}$ , with the following formula:

$$L_{max} = L_{tab} (U_i / U_n)^2$$